

NO	Dim.		Col.-No	Qty
1	1000	390	1	1
2	575	342	1	1
3	410	380	1	1
4	1341	360	1	1
5	183	360	1	1
5a	470	180	1	1
5b	183	360	1	1
5c	530	209	1	1
6	1341	342	1	1
7	836	108	1	1
8	1335	405	1	1
9	510	180	1	1
9a	470	80	1	1

NO	Dim.		Col.-No	Qty
9b	510	180	1	1
9c	530	440	1	1
10	1350	387	1	1
11	829	584	1	1
12	378	320	1	3
13	567	300	1	1

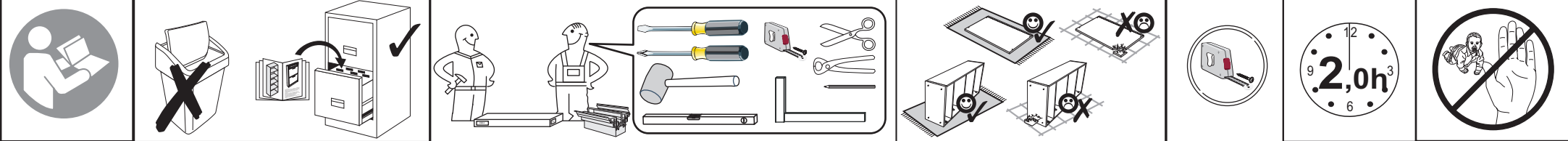

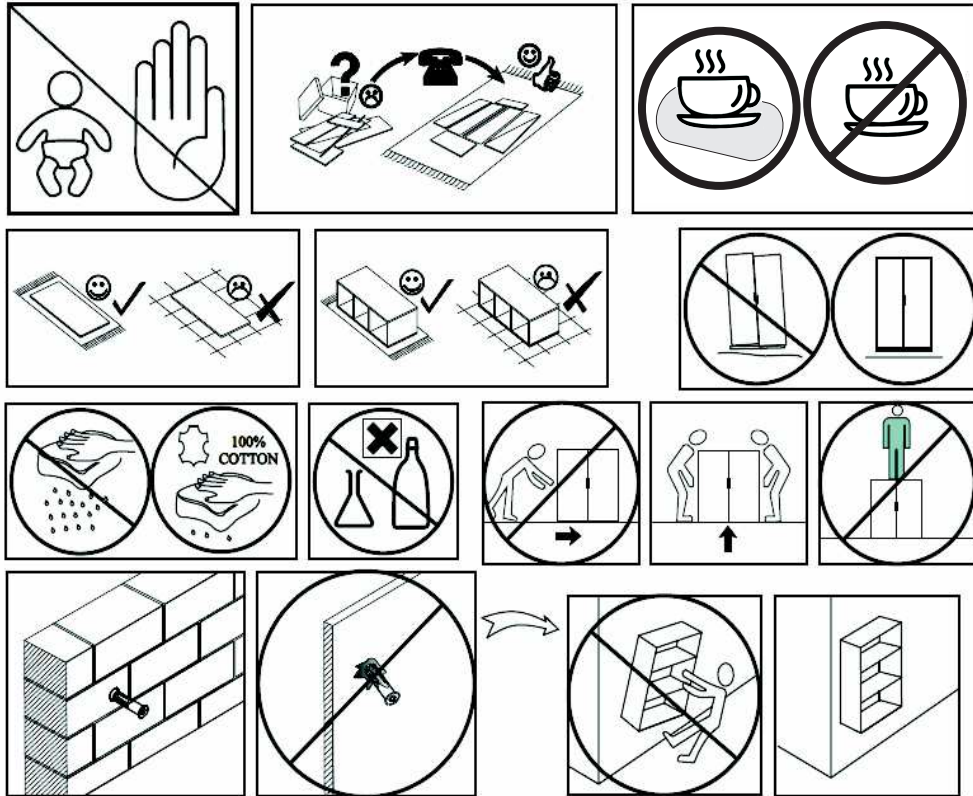
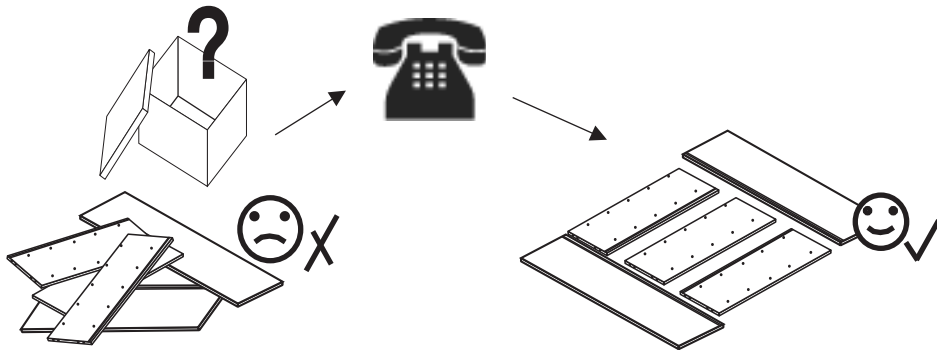

<http://www.innstyle-mvg.de>



BG	Bulgarisch	български
CS	Tschechisch	čeština
DA	Dänisch	Dansk
DE	Deutsch	Deutsch
ET	Estnisch	Eesti
EL	Griechisch	ελληνικά
EN	Englisch	English
ES	Spanisch	español
FR	Französisch	Français
FI	Finnisch	suomalainen
HR	Kroatisch	hrvatski
HU	Ungarisch	magyar
IT	Italienisch	italiano
LV	Lettisch	Latvijas
LT	Litauisch	Lietuvos
NL	Niederländisch	Nederlands
PL	Polnisch	Polski
PT	Portugiesisch	português
RO	Rumänisch	român
SK	Slowakisch	slovenský
SL	Slowenisch	slovensčina
SV	Schwedisch	Svenska



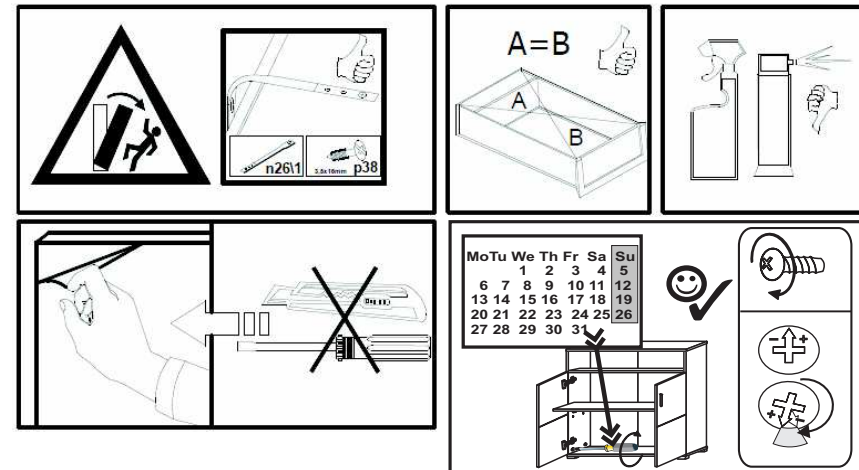

Möbelvertriebsgesellschaft mbH & Co. KG





**NR 1**

**B1**   $\phi$  8x28 x14

**B20**   $\phi$  8x50 x4+2

**M1**   $\phi$ 15x12mm x23

**T1**  5x39mm x19

**T12**  x2

**C14**   $\phi$ 20mm x25

**J23**  x13

**NR 2**

**W1**  x12

**W3**  x3

**G4**  x9+6

**P16**  4x16 x9+6

**NR 3**

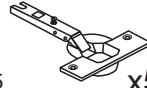
**Y0**   $\phi$  35 x5

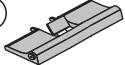
**Z5**  x2

**D7**  x5

**E3**  6,3x13 x10

**S8**  4x13 x10

**NR 4**

**C3514**  x2

**A2**  M4x25 x4

**NR 5**

**N20**  x4

**S2**  4x30 x8

**NR 6**

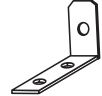
**J11**  x1

**P13**  3,5x13 x2

**T13**  8x50 mm x1

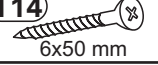
**T14**  6x50 mm x1

**NR 7**

**Z01**  x1

**NR 8**

**POI**  x1

**TT320**  x1



# 1

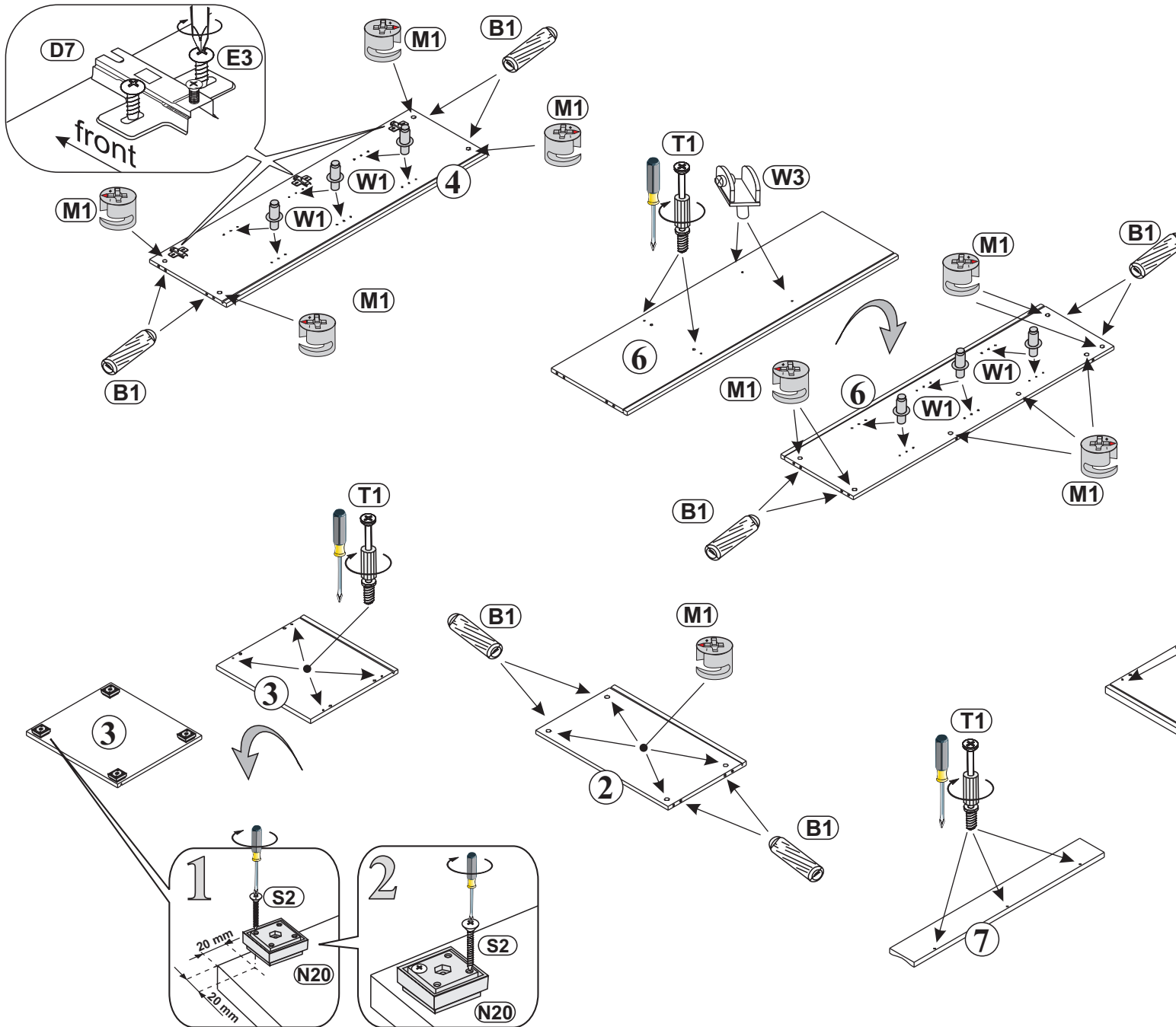

<b>T1</b> 5x39mm x15	<b>B1</b> φ 8x28 x12
<b>N20</b> x4	<b>M1</b> φ15x12mm x15
<b>S2</b> 4x30 x8	<b>D7</b> x3
<b>W3</b> x3	<b>E3</b> 6,3x13 x6
	<b>W1</b> x12

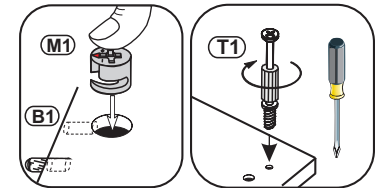

## 2

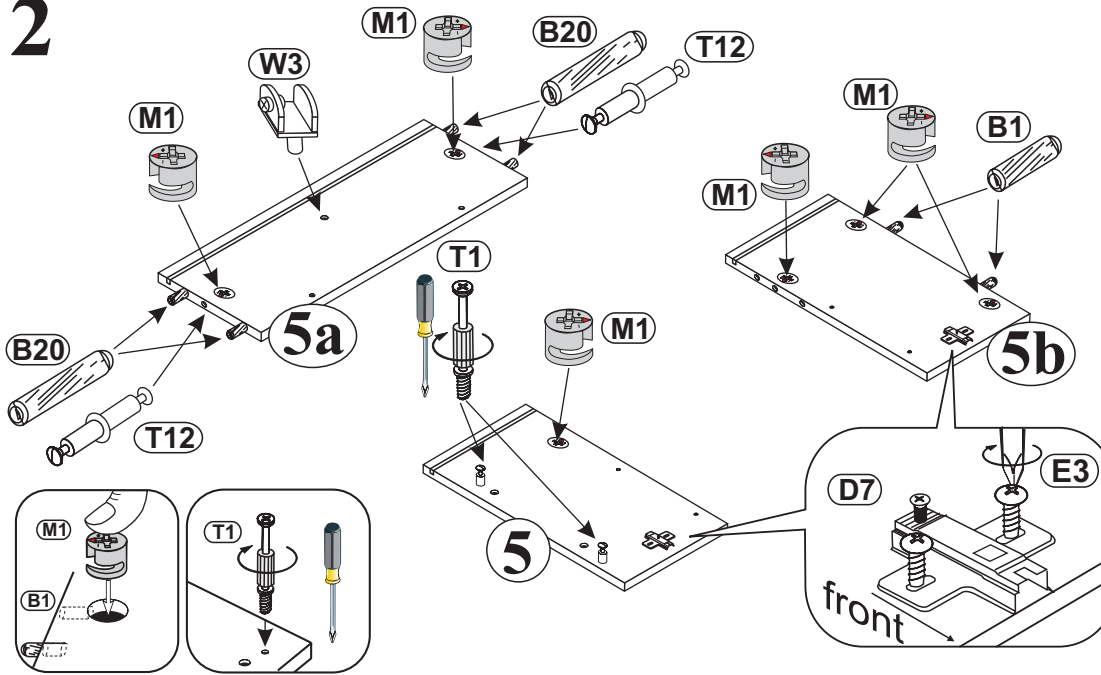

- B20**  $\phi$  8x50 x4
- W3** x1
- B1**  $\phi$  8x28 x2
- M1**  $\phi$  15x12mm x6
- T12** x2
- T1** 5x39mm x2
- D7** x2
- E3** 6,3x13 x4

## 3

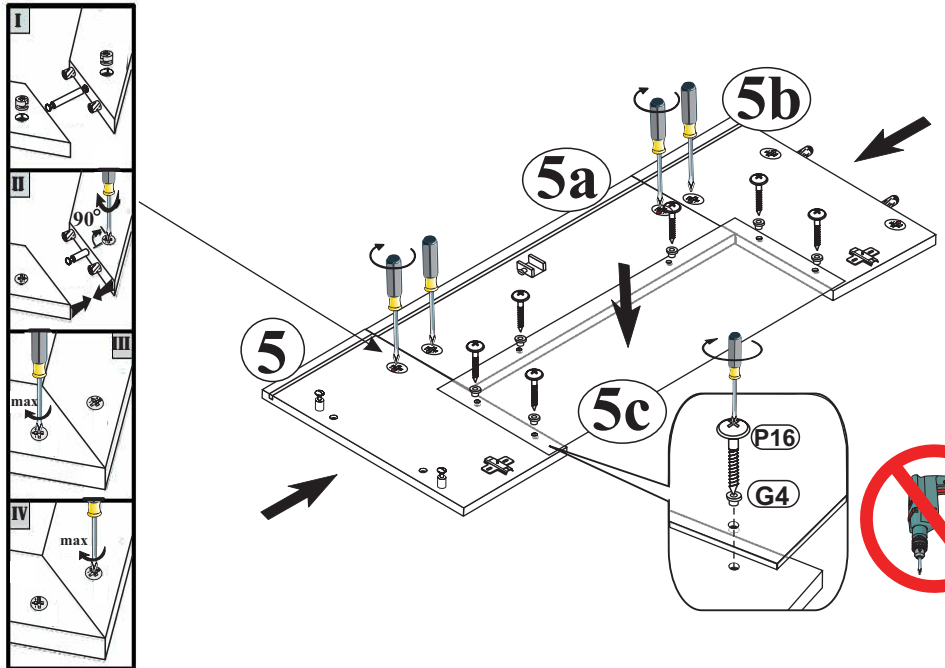

- P16** 4x16 x6
- G4** x6

## 4

- M1**  $\phi$  15x12mm x2
- T1** 5x39mm x2
- Z5** x1
- B20**  $\phi$  8x50 x2
- Y0**  $\phi$  35 x2
- S8** 4x13 x4

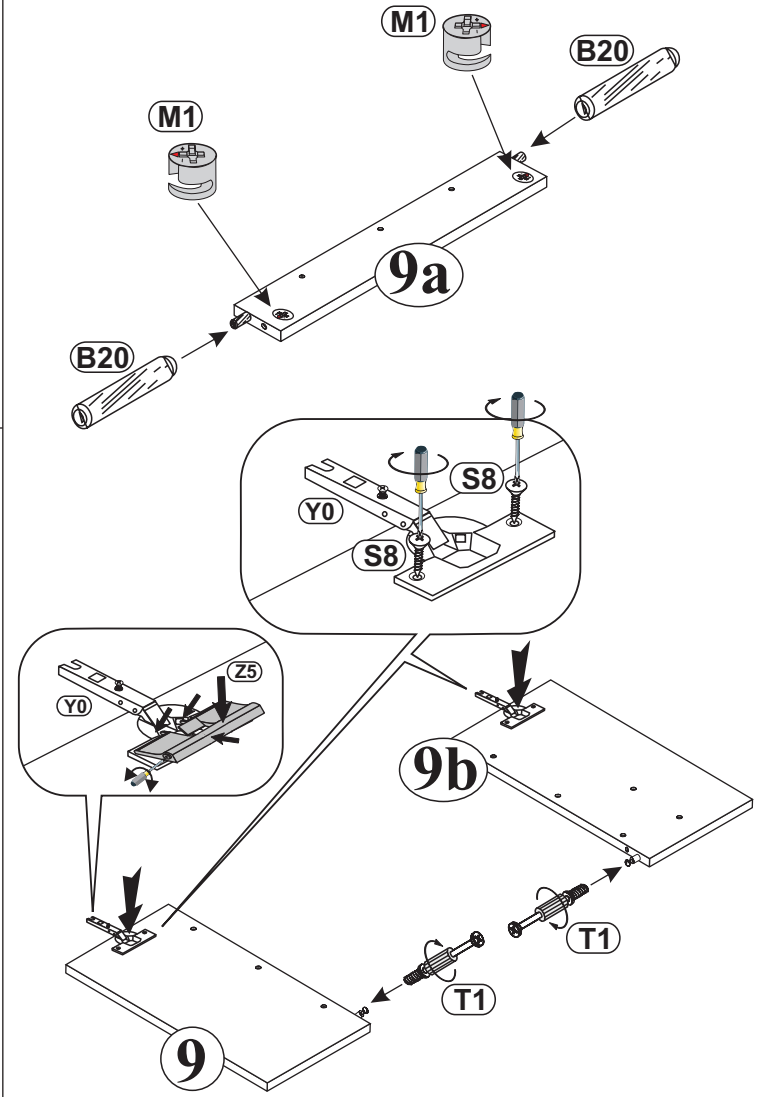

## 5

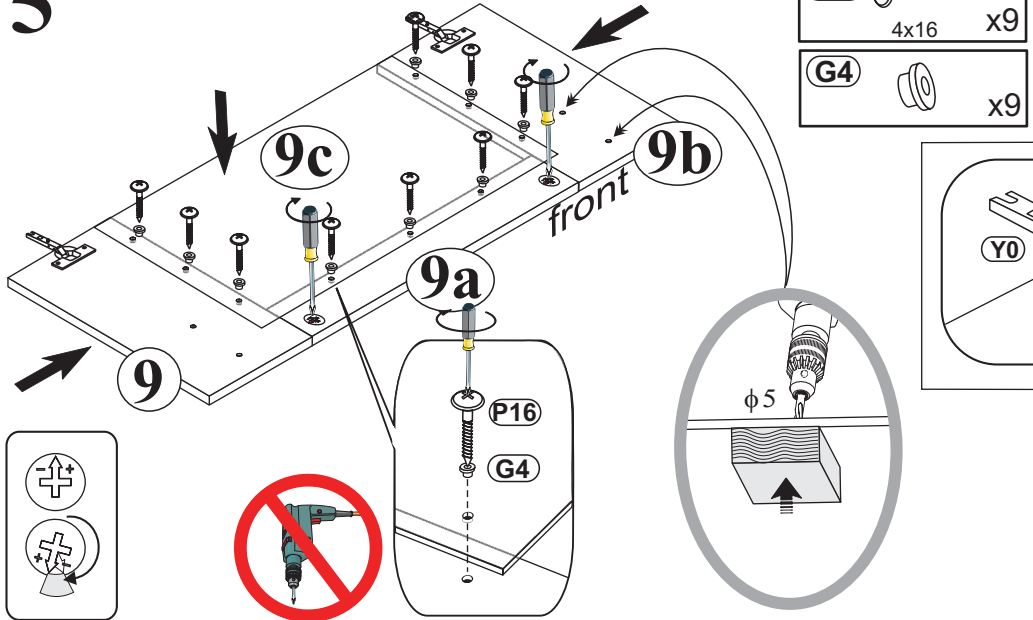

## 7

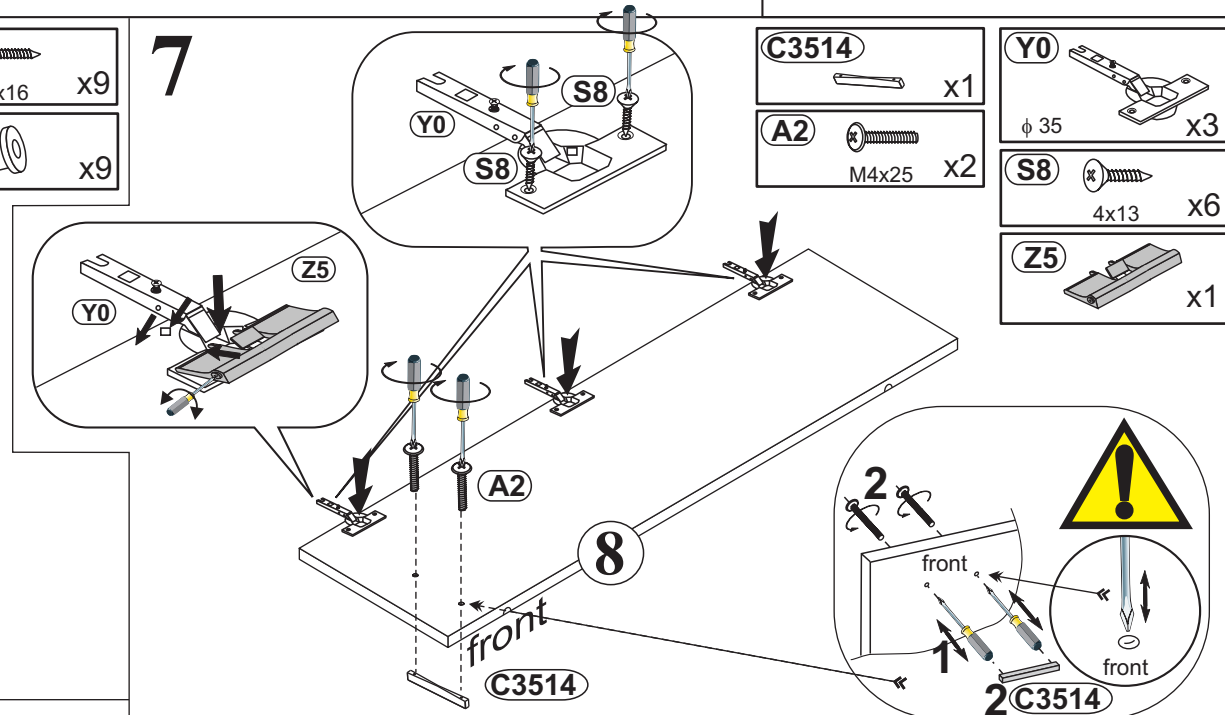

## 6

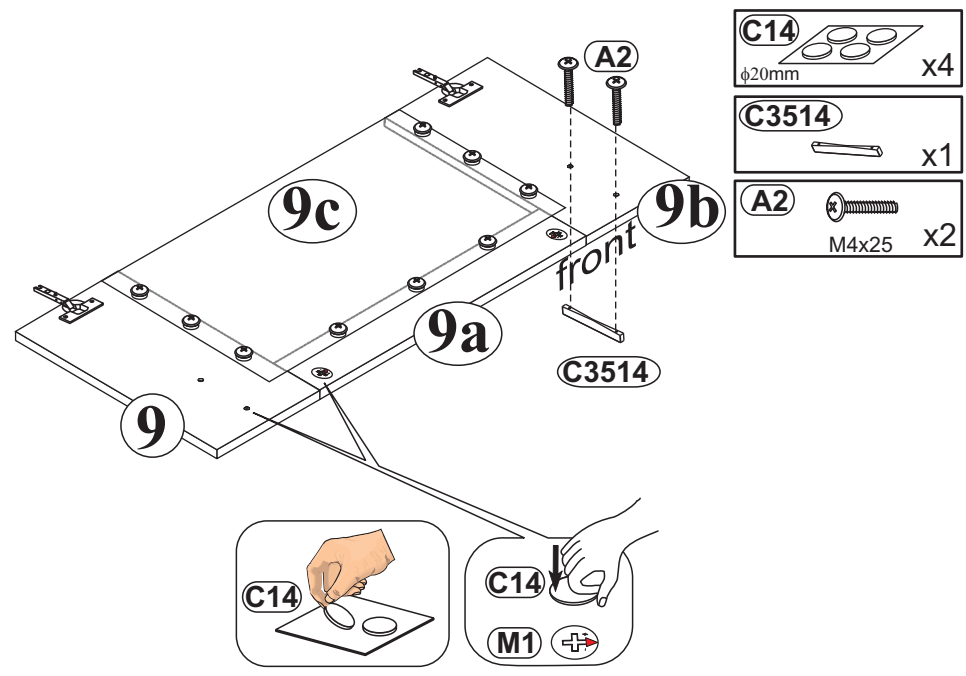

## 8

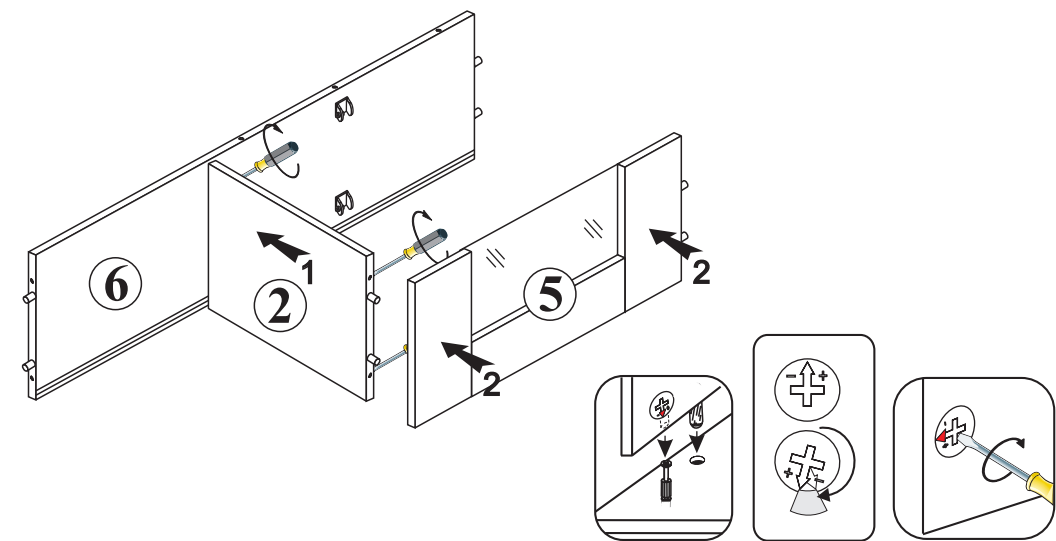

9

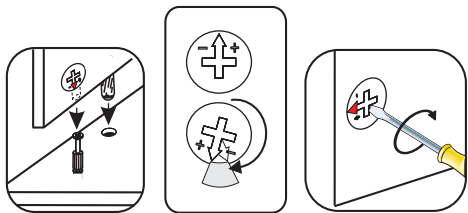
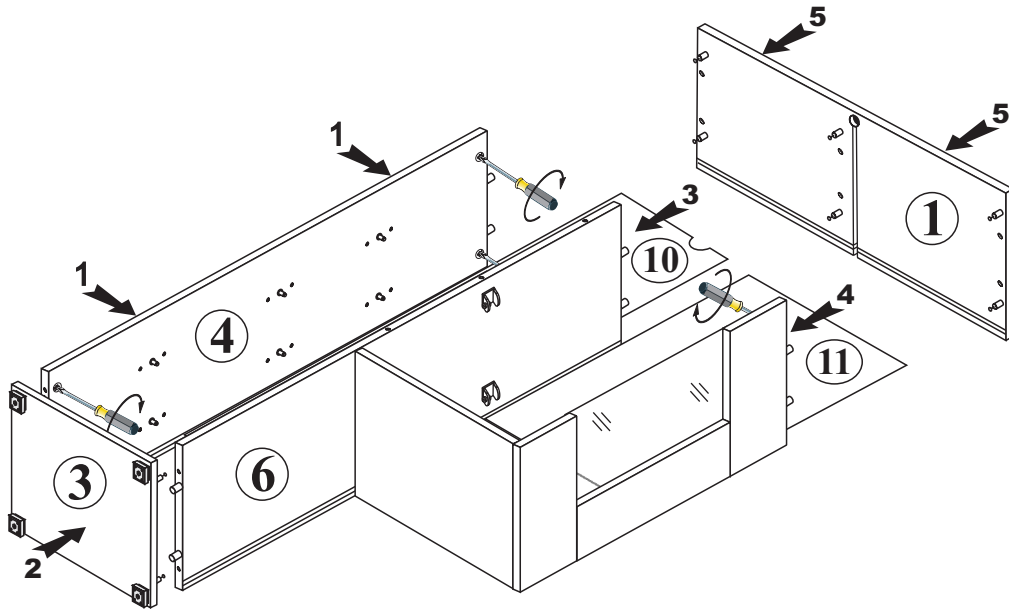

10

J23  x13

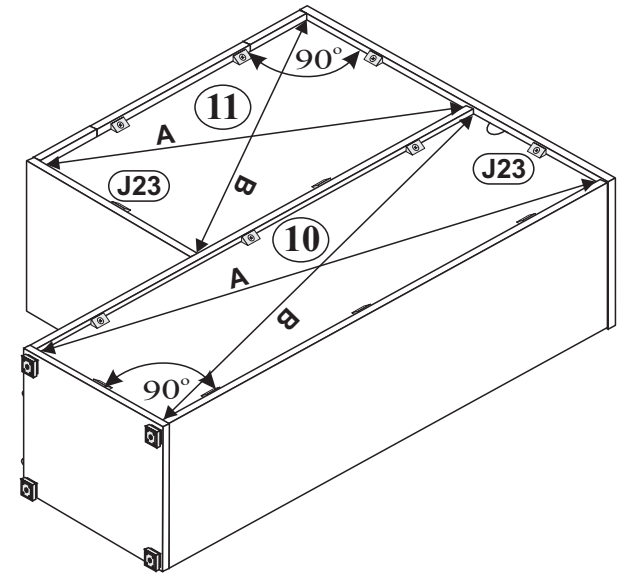

A=B

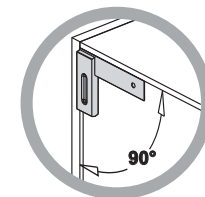
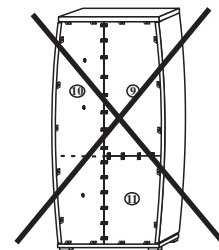

1

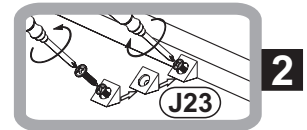

2

## 11

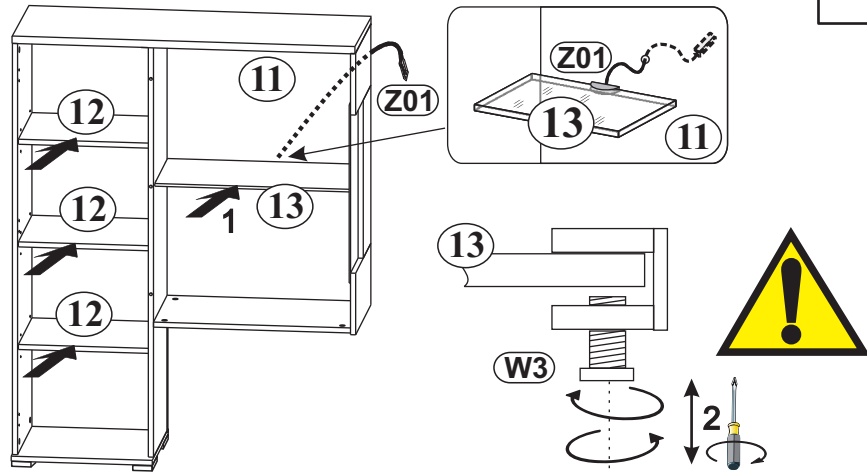

## 13

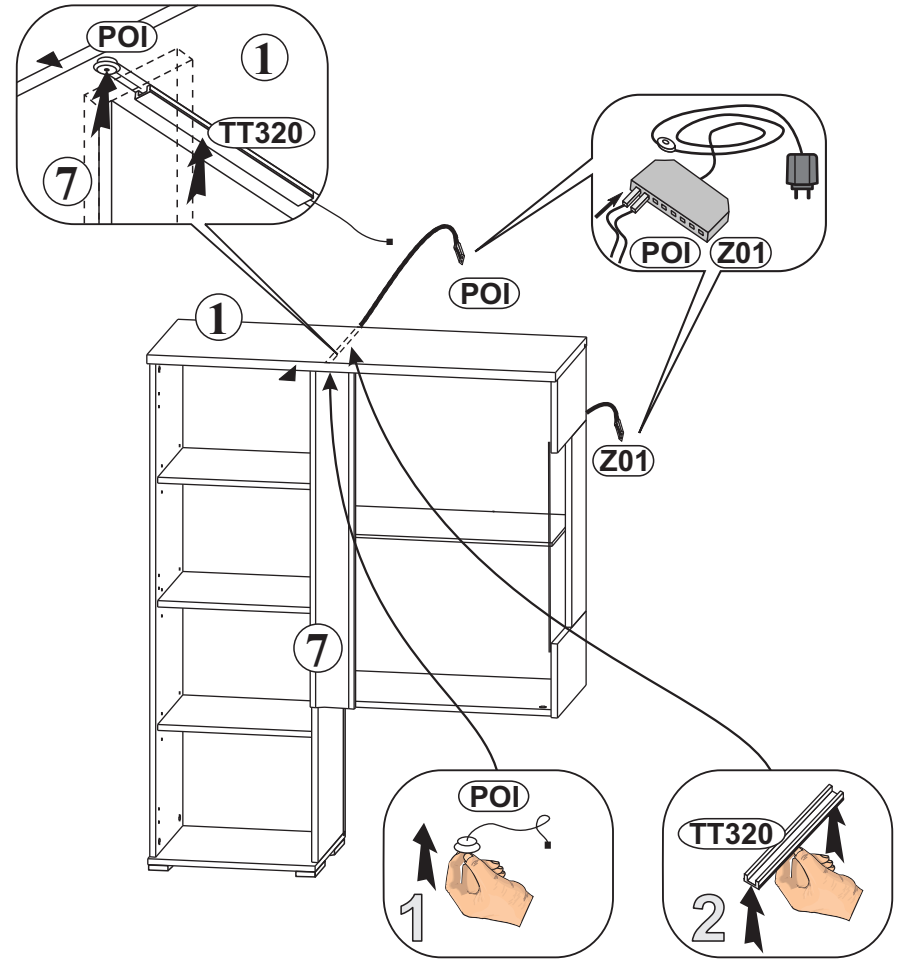

## 12

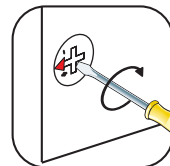
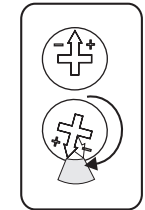
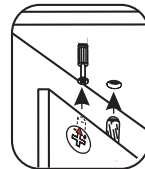
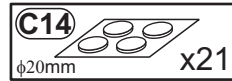
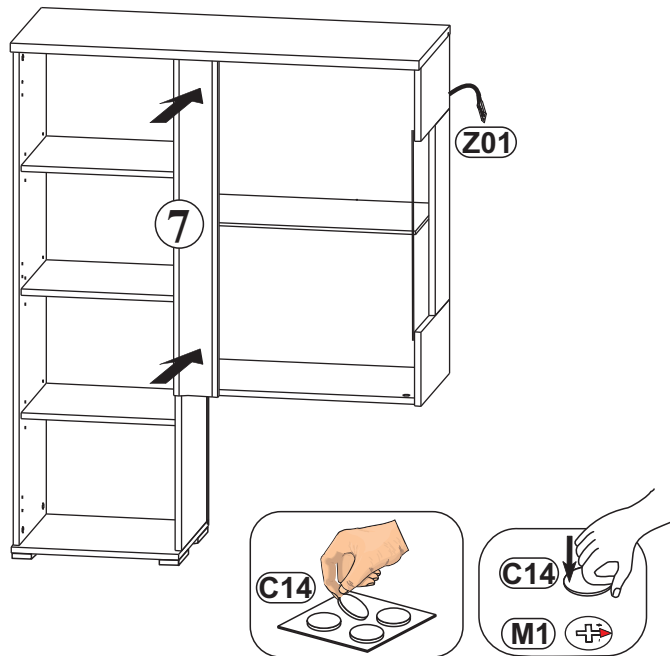



# 14

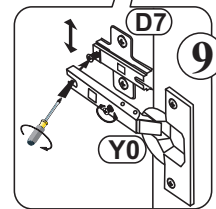
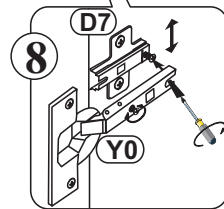
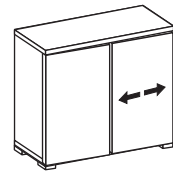
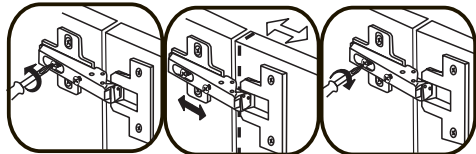
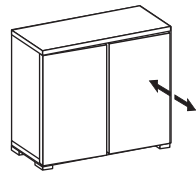
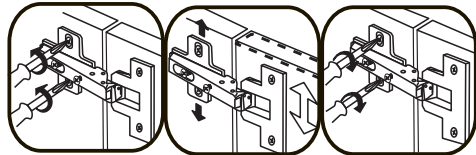
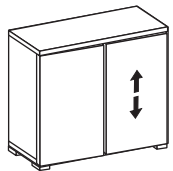
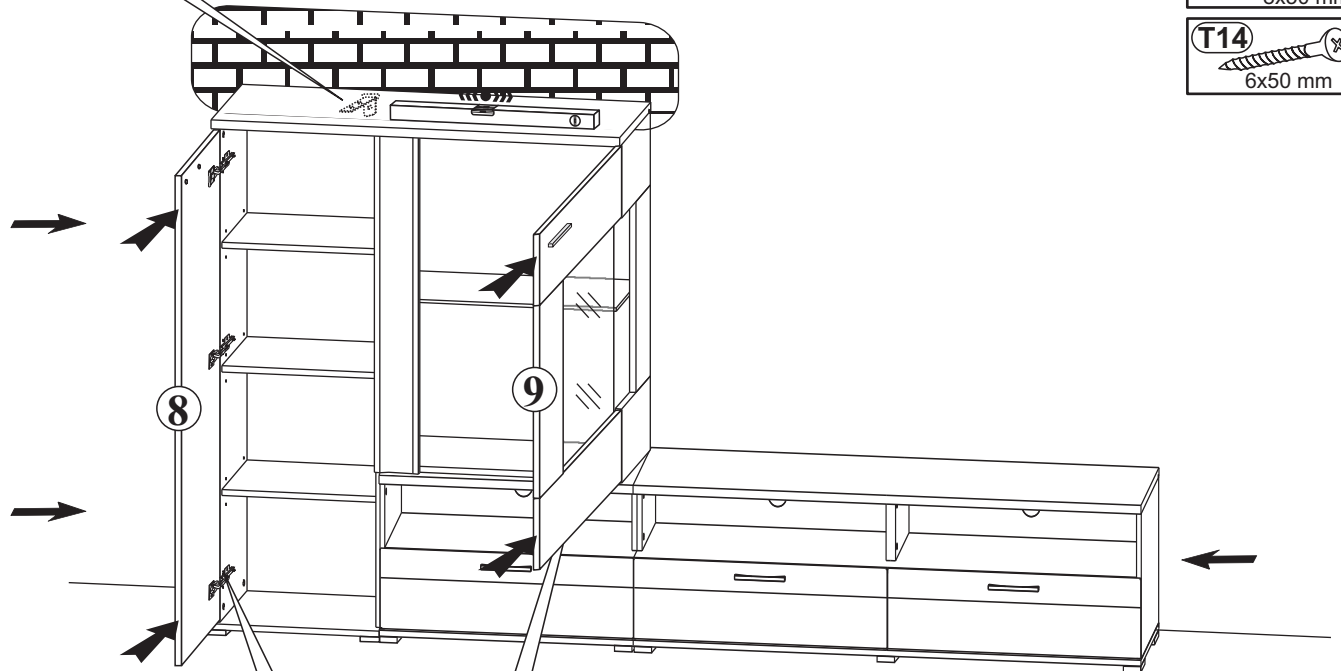
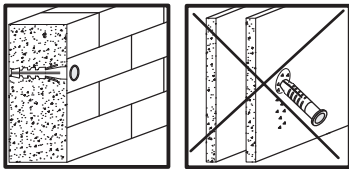
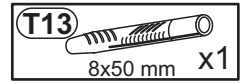
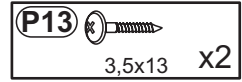
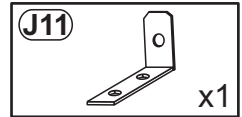
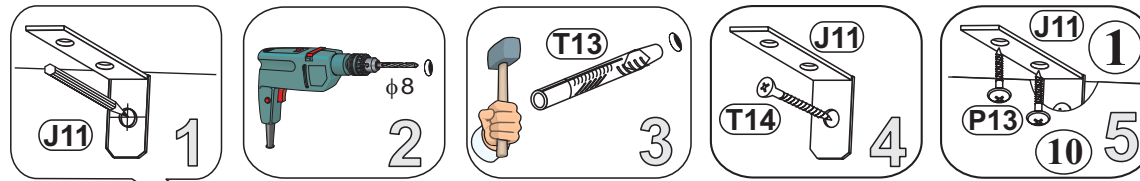
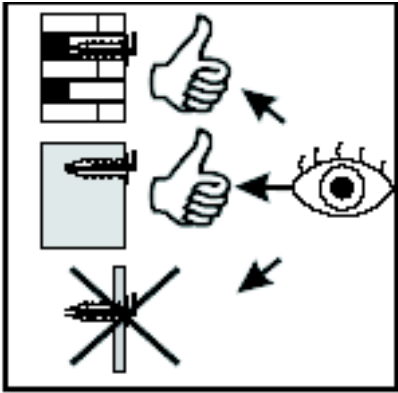

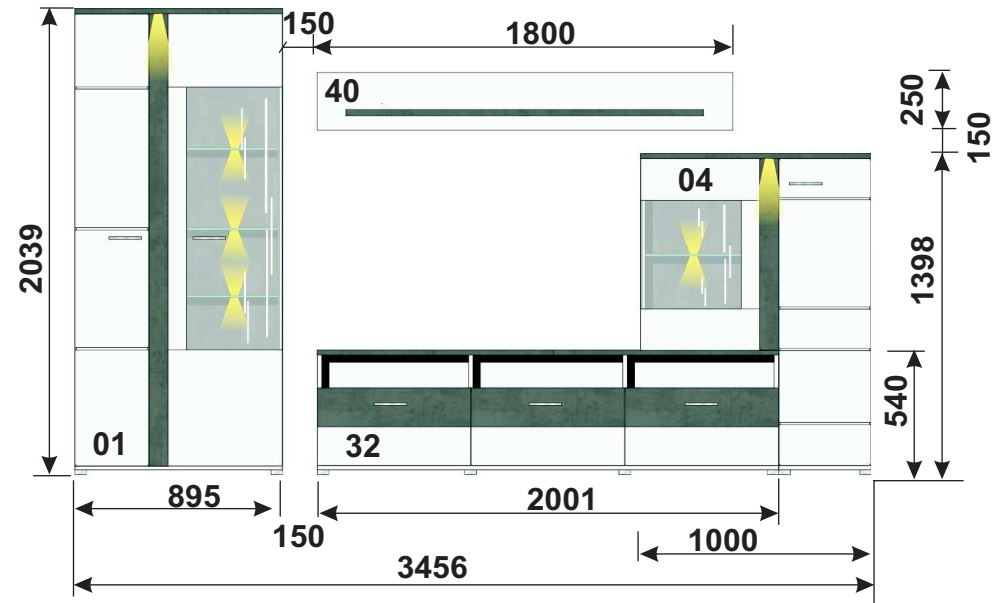
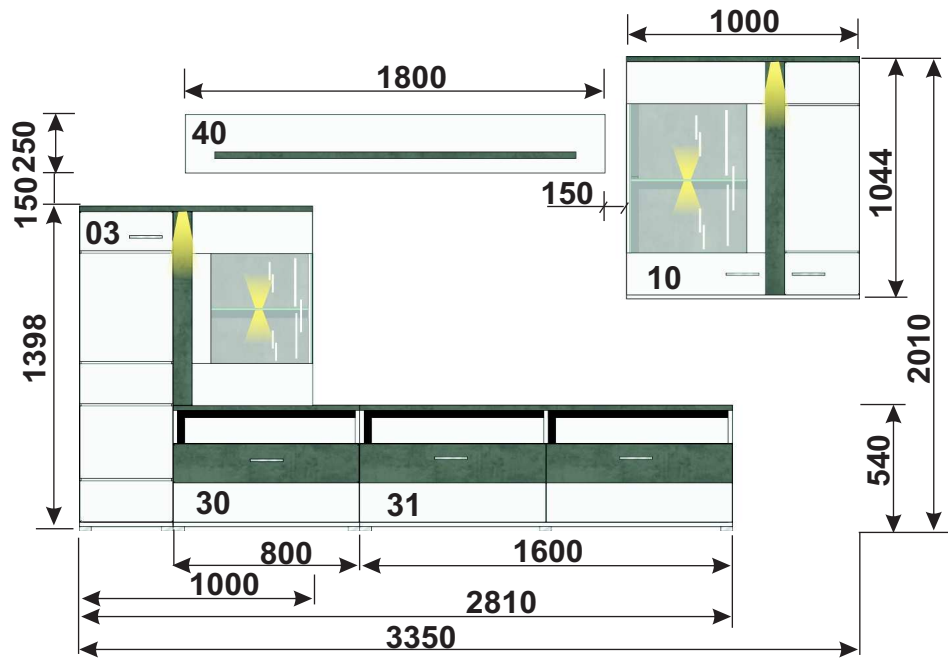

**D CH AT LI LU** Kleinstele und Verpackungsfolien bei der Möbelmontage von Kindern fernhalten!  
**GB US** Keep small parts and plastic film out of the reach of children!  
**FR BE NC** Tenir les petites pièces et les films plastiques hors de la portée des enfants!  
**NL** Hou de kleine onderdelen en de plastic folie uit de buurt van kinderen!  
**IT** Tenere i componenti di piccole dimensioni e le pellicole di plastica fuori dalla portata dei bambini!  
**SI** Malhni delov i foliju za pakovanje priklom montaži pohištna priane izven dosega otrok!  
**XS HR BA** Mahe dijelove i foliju za pakovanje priklom montaže namještaja držite dalje od djece  
**HU** Bútorészeket közbden a kis alkatrészek és a csomagoló fóliák gyerekekkel távol tartandók!  
**BG** Дребни детайли и опаковъчни фолия да се държат далеч от деца при монтажа на мебелите!  
**CZ SK** Vid montáži nábytku uchovávejte drobné díly a obalové fólie z dosahu dětí!  
**SE** Vid möbelformering ska smådelar och förpackningsfolien hållas oåtkomliga för barn!  
**RO** Țineți departe de copil piesele mici și folia de ambalat la montarea mobiliei!  
**ES** ¡Durante el montaje, mantenga alejados de los niños las piezas pequeñas y el material plástico de embalaje!

**D CH AT LI LU** Möbelmontage muss auf ebennem Untergrund erfolgen. Bei Wandmontagen immer geeignetes Befestigungsmaterial verwenden.  
**GB US** Furniture must be assembled on a flat surface. For assembly to the wall only use suitable fixing materials.  
**FR BE NC** Le meuble doit être monté sur une surface plane. Pour le montage mural, utilisez des accessoires de fixation adaptés au type de mur.  
**NL** De meubels dienen op een vlakke ondergrond te worden gemonteerd. Voor wandmontage moeten geschikte bevestigingsmaterialen worden gebruikt.  
**IT** Il montaggio dei mobili deve avvenire su un fondo piano. Per il montaggio si prega di utilizzare solo materiali adatti.  
**SI** Pohištvo je treba montirati na ravni podlagi. Pri stenski montaži vedno uporabite pritrilveni material.  
**XS HR BA** Namještaj se mora montirati na ravnoj podlozi. Kod montaže na zid uvijek koristite prikladan materijal za pričvršćivanje.  
**HU** A bútorcszerelési silk felületen kell végezni. Falra szereléshez mindig megfelelő rögzítianyagot kell használni.  
**BG** Монтажът на мебелите да се извършва на равна основа. При стенен монтаж винаги да се използва подходящ крепежен материал.  
**CZ SK** Montáž nábytku provádějte na rovném podkladu. Při montáži na stěnu používejte vždy vhodný příslušovací materiál.  
**SE** Monterिंग av möbeln måste göras på jämnt underlag. Vid väggmontering ska lämpligt uppfästingsmaterial användas.  
**RO** Montarea mobiliei trebuie să se realizeze pe o pardoseală dreaptă. La montarea la perete utilizați întotdeauna material de fixare adecvat.  
**ES** El montaje debe efectuarse sobre una superficie uniforme. En el montaje mural emplee siempre el material de fijación adecuado.

**D CH AT LI LU** Bitte beachten Sie die Montageanleitung. Halten Sie immer die angegebene Wattzahl ein. Verhindern Sie einen Hitzestau.  
**GB US** Please observe the assembly instructions. Do not exceed the max. given wattage. Ensure that the heat is not allowed to build up.  
**FR BE NC** Veuillez respecter la notice de montage. Respectez impérativement le nombre des watts maximal. Veillez à éviter toute accumulation de chaleur.  
**NL** Lees a.u.b. de montagehandleiding door. Hou de beslist aan het max. opgegeven wattage. Zorg ervoor dat geen hittehuwling onstaat.  
**IT** Attenersi alle istruzioni di montaggio. Rispettarsi rigorosamente il numero di watt max. indicato. Assicurarsi che non si verifichi un accumolo di calore.  
**SI** Upoštevajte navodila za montažo. Vedno upoštevajte navedeno število vatov. Preprečite zastoj vročine.  
**XS HR BA** Obratite pažnju! Vas pozor na uputu za montažu. Uvijek se pridržavajte navedenog broja vat. Izbjegavajte zastoj vrućine.  
**HU** Vegye figyelembe a szerelési útmutatót. Mindig tartsa be a megadott wattszámot. Akadályozza meg a hőelődést.  
**BG** Моля, вземете под внимание ръководството за монтаж. Спазвайте винаги посочените ватове. Избягвайте акумулиране на топлина.  
**CZ SK** Dodržujte prosím návod k montáži. Vždy dodržujte uvedenou hodnotu výkonu (watt). Zabráňte tak přehřívání.  
**SE** Följ monteringsanvisningen. Följ alltid angivet watttal. Undvik att hetta uppstår.  
**RO** Respectați instrucțiunile de montaj. Respectați întotdeauna numărul de watt impus. Evitați acumularea de căldură.  
**ES** Le rogamos que tenga presente las instrucciones de montaje. Respete siempre el número indicado de vatios. Evite la acumulación de calor.

**D CH AT LI LU** Halten Sie die max. zulässigen Belastungswerte der Möbelteile ein. Details siehe Montageanleitung  
**GB US** Comply with the max. permissible loads. For details, please refer to the assembly instructions  
**FR BE NC** Respectez les valeurs de charge max. admissibles des parties de meubles. Pour plus de détails, cf. la notice de  
**NL** Hou de maximaal geoorloofde belastingswaarden van de meubeldelen aan. Voor details verwijzen wij naar de montagehandleiding  
**IT** Rispettare la portata max. permessa degli elementi del mobile. Per dettagli si vedano le istruzioni di montaggio e si vada  
**SI** Upoštevajte največjo dovoljeno obremenitev delov pohištna. Podrobnosti najdete v navodilih za montažo in na  
**XS HR BA** Tartsa be a bútorelemek max. megengedett terhelési értékét. A részleteket lásd a szerelési útmutatóban  
**HU** Tartsa be a bútorelemek max. megengedett terhelési értékét. A részleteket lásd a szerelési útmutatóban  
**BG** Спазвайте макс. допустимите стойности на натоварване на мебелите. За подробности виж ръководството за монтаж  
**CZ SK** Dodržujte max. přípustné hodnoty zatížení nábykových dílů. Podrobnosti viz návod k montáži  
**SE** Följ max. tillåten belastning av möbeldelarna. Mer information finns i monteringsanvisningen  
**RO** Respectați valorile de solicitare max. admise pentru corpurile de mobilier. Pentru detalii consultați instrucțiunile de montaj  
**ES** Respete los valores máximos de carga admisibles para las piezas de los muebles. Consulte los detalles en las instrucciones

**D CH AT LI LU** Zur Möbelfeinigung ein mit Wasser befeuchtetes, fusselfreies Baumwolltuch verwenden. Geeignigte Flächen immer trockenreiben!  
**GB US** To clean the furniture only use a water dampened lint-free cotton cloth. Once cleaned, always wipe the surfaces dry.  
**FR BE NC** Utilisez un chiffon en coton non pelucheux humidifié avec de l'eau pour nettoyer les meubles. Séchez systématiquement les surfaces  
**NL** nettoyées en les frottant!  
**IT** Gebrauk een met water bevochtigde, pluusvrije katoenen doek om de meubels te reinigen. Wrijf gereinigde oppervlakken altijd droog!  
**SI** Per pulire il mobile utilizzare un panno di cotone inumidito d'acqua e che non perde pelucchi. Asciugare sempre le superfici che si sono  
**XS HR BA** krpomi!  
**HU** Za čišćenje pohištva uporabljajte vlažno bombažno krpo, ki ne pušča vlaken. Očiščene površine vedno obrišite do suhlega!  
**BG** За čišćenje namještaja koristite sa vodom navlaženu pamučnu krpu koja ne ispušta vlakna. Očiščene površine uvijek obrišite suhom  
**CZ SK** K čištění nábytku používejte bavlněný hadr neuvloňující vlákna, navlhčený ve vodě. Učištěné plochy vždy utřete do sucha!  
**SE** För möbelfeörning används en luddfritt bomullsduk fuktad med vatten. Rengörda ytor ska alltid torftas torra!  
**RO** Pentru curățarea mobiliei utilizați o lavetă din bumbac fără scame umezită cu apă. Suprafețele curățate se șterg întotdeauna până se usucă!  
**ES** Emplee un paño de algodón humedecido con agua y libre de pelusa para la limpieza de los muebles. ¡Seque siempre las superficies que ha limpiado!